

Scale: 1 : 3.5  
 Wingspan: 2.55 m  
 Fuselage length: 2.12 m  
 Engine: Titan ZG 80  
 Takeoff weight: 13.3 kg  
 Wing area: 1.77 m<sup>2</sup>

# Albatros DVa

The Albatros DV is without doubt the most interesting and attractive single seater fighter built by the Germans in the first world war. We have been working for a very long time on our 1:3.5 model, to produce a really out of the ordinary kit. From the beginning of our Albatros project, we wished to break away from the conventional type of construction, to make something totally new in every aspect, with a perfect solution to the many design problems encountered, quick to build, with superb

flying characteristics. For us, it was of utmost importance to have a really robust model, capable of withstanding any amount of transport, although light in weight. As we visit so many flying meetings, we need to be able easily stow the Albatros in our station wagon. An important factor was, and is, to keep the assembly of the model on the flying field as simple as possible. The pilot who is ready first fly in the not so turbulent early morning air, and has the airspace for himself.



*With our albatross, one can take off with quarter throttle, and with even less throttle continue flying. This way the ZG 80 has a very realistic sound. The six cylinder Mercedes engine at maximum take off power was only making 1500 RPM.*

In spite of the extensive prefabrication, we were not aiming at an ARF model, leaving the customer faced with the tedium of the final installation work. These gleaming ARF playthings give rise to boredom after some flights, if they have not already fallen to pieces in the meantime, due to poor design and commercial exigencies.

Due to the extensive prefabrication, you will find the Albatros will quickly take shape on your building board. Just to mention two examples: the GRP fuselage with all scale formers and stringers built in, and the wings with hard aluminium tubing for spars, and ready formed GRP leading edge sheeting with wing tips. Even so there is more than enough to do with building the Albatros. It is a real joy to see your Albatros growing piece by piece on your building board. Here and there a part being added, causing your model to resemble progressively the full-size. Certainly the Albatros is not only an attractive model, it makes for real pleasure in flying. You can do everything the full-size did at the "Shuttleworth Uncovered" flying day in Old Warden, but there are more capabilities in this machine, an unusually aerodynamic and elaborate construction for its time.



### The Wings

Thinwall high tensile aluminium alloy tubing is used for the spars, this makes for an incredibly light but torsionally very stiff construction. Wing failure caused by flutter meant the total loss of a number of full-size machines, and pilots. The single lower wing main spar was located too far back. In those days the aerodynamic cause of flutter was not properly understood by aircraft designers.

The model's leading edge, with integral curved wing tip sheeting, is a single GRP piece made from a CNC milled pattern. This has the pleasurable advantage of not increasing the depth of balsa dust in the hobby room, as well as ensuring a very accurate wing section and reducing construction to a minimum.

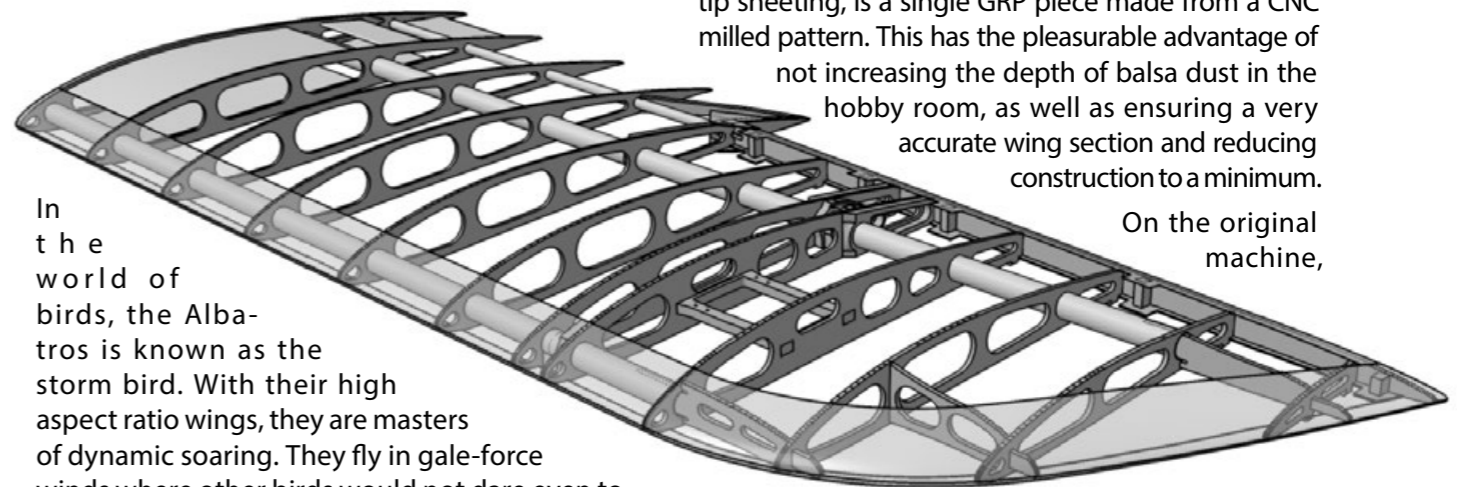

In the world of birds, the Albatros is known as the storm bird. With their high aspect ratio wings, they are masters of dynamic soaring. They fly in gale-force winds where other birds would not dare even to walk. The model hardly deviates from the bird in this respect. The optimal moment arm, the elliptical fuselage section, and a triangular sub-fin coupled with a low fin and rudder, allow the Albatros to make straight as a die starts, and that without built-in side thrust. Our Albatros even climbs in knife edge, makes wide diameter loops, positive as well as negative, rolls very slowly as well as quickly, and hangs on the propeller, like a modern aerobatic airplane. If you can simultaneously and independently control all three axis, like the bird, you will be able to fly in the strongest winds.

I sometimes find myself wondering how von Richthofen would have flown, if his Albatros DV had been as light, powerful and strong as our model?

the trailing edge was a single strand of wire. When covered with linen and doped, the inevitable shrinkage gave rise to the well know scalloped TE.

We have used a single strand of Kevlar rovings attached with cyano glue to the rib ends. The rovings are loose enough to allow the ProfiCover when it shrinks to form the scalloping perfectly.

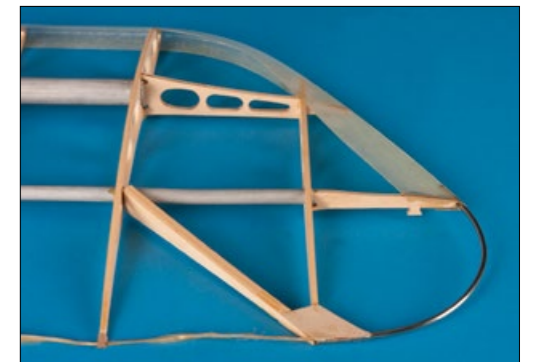



### Why a epoxy/glass fuselage?

The Albatros fuselage is curved in both directions. The fuselage skin consists of four shells, upper, lower, left, and right side shells. These shells were formed by pressing plywood panels into a concrete mould and gluing them together while still in the mould. Without using this elaborate and complicated technique it is impossible to obtain an exact replica of the original fuselage in plywood. Our solution is a GRP fuselage, with an exact geometric shape and wood grain effect.

The wood grain is formed in the white gelcoat of the GRP fuselage by painting the fuselage with black paint, then wiping this off with steel wool, leaving the grain very visible. This then is sprayed with a two component matt transparent paint with a little yellow and brown colour added, the plywood fuselage is then ready.

Moulded in the fuselage are the four aluminium reinforcements to take the wing centre section struts



In the cockpit area the fuselage is planked with 0,4 plywood so there is no glassfiber laminate visible.

and undercarriage, the ready drilled firewall, with crown nuts fitted for the engine fixing screws, all scale formers and stringers in the cockpit, the holes formed in the wing and tailplane stubs, also the rudder king post in the fin, with holes for the hinges. All these parts have been CNC milled and fitted accurately into the wet laminate, making the joint really strong, without the unsightly "runs" of epoxy resin spoiling the view.

### Building manual

An impressive building manual belongs in an impressive kit. All phases of construction are described in 150 pages, detailing exactly the construction with approx. 300 illustrations and photo's. All the milled plywood parts are shown on printed paper sheets to enable easy identification.

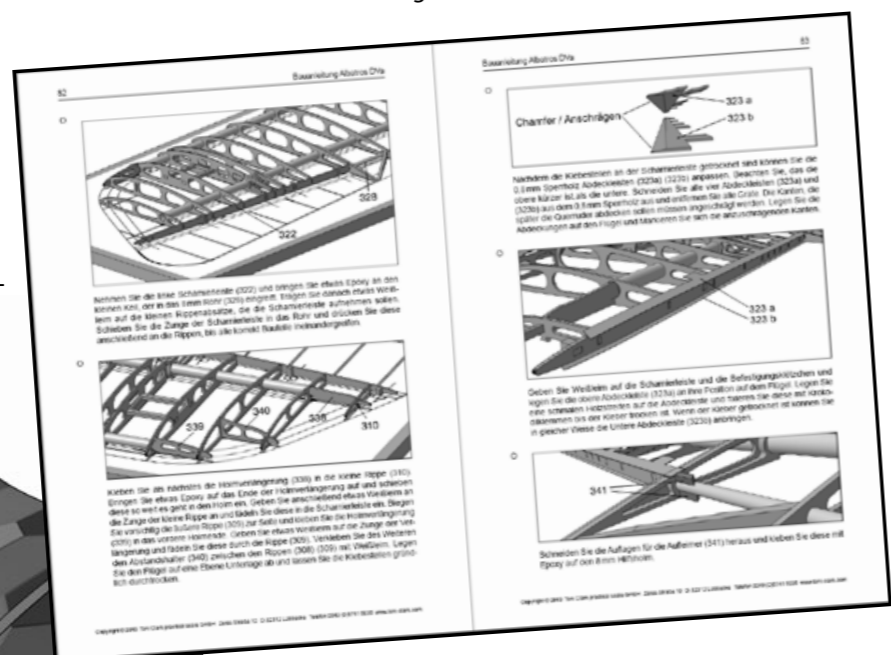
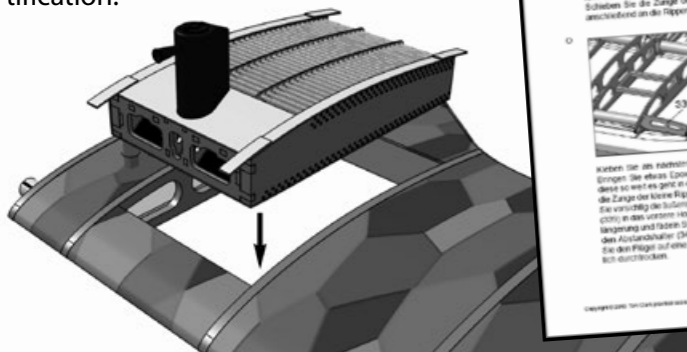

### The simulated Teeves water cooler

Here our construction is NOT a simple vacuum formed unit that only roughly resembles the original, it is a small kit inside a big kit. The body consists of a sandwich construction made of wood and polystyrene. This resembles the original accurately and has a smooth, ready to paint surface like metal, showing no trace of wood grain. There is a jig supplied to make construction simple and accurate by spacing the sides and parting walls. For simulation of the cooling tubes, there are 160 pieces of tubing cut to length, which end to end would make 19 meters. The aileron servo cables are hidden in the return flow aluminium water pipe.

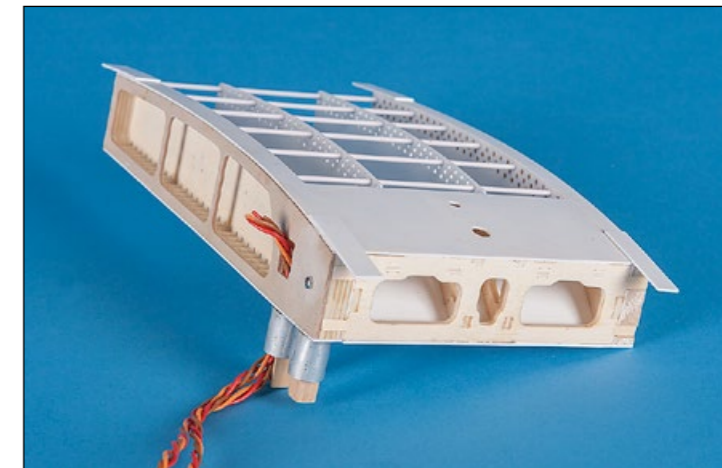

By the way: you will not find any burnt wood edges in our kit. Instead of laser cutting, we prefer the rather more time consuming and expensive CNC milling. There are also some 3D milled parts in the kit. You cannot make these with a laser cutter.

### Tailplane

The tailplane is made from sandwich Rohacell-GRP construction. When these are painted, you cannot see any difference to the classic rib construction, with sewn rib tapes and the covering material characteristically slightly sinking between the ribs.

The tailplane halves are easily removeable for transport.

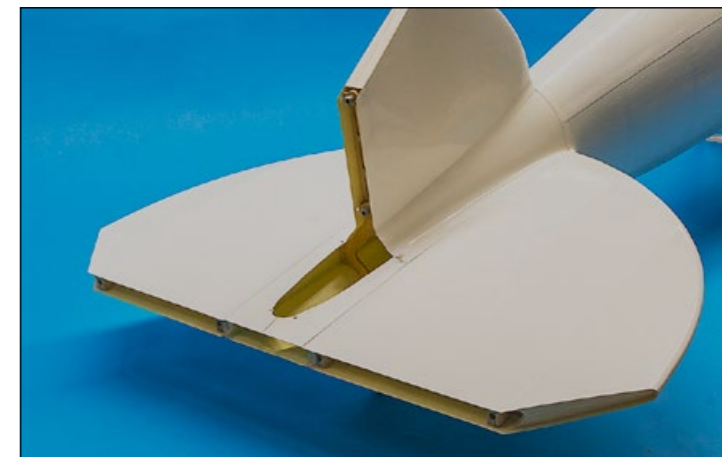

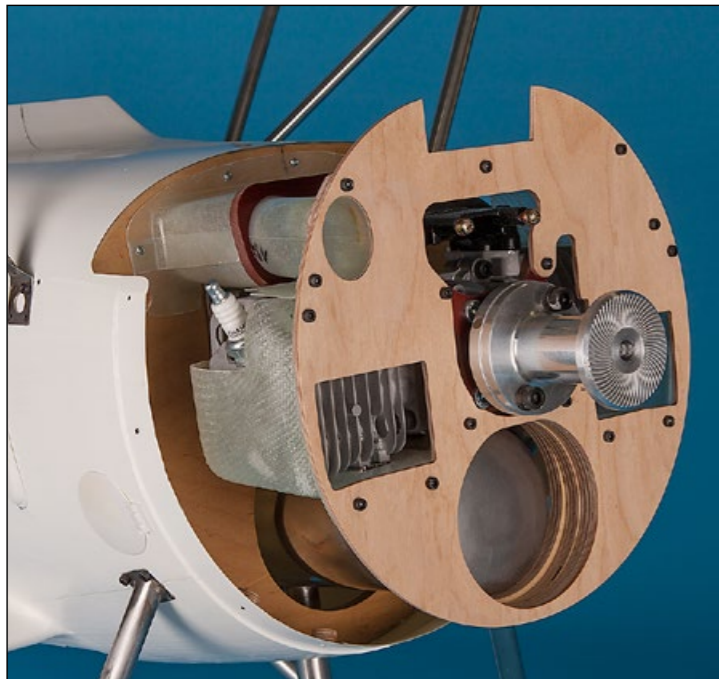

### Efficient engine cooling system

We spent a lot of time, and money, developing this cooling system for the ZG80 to our satisfaction. The scale gap between the cowl and spinner is sufficient to cool both the engine and silencer and also provides enough cool air for the carburetor. Perhaps you wonder why the carburetor is fully enclosed, not able to suck in air out of the fuselage interior. The top engine cowl directs hot air past the machine guns where it can enter the fuselage through the cockpit opening. If we were to suck this warm air into the engine, after running a long while at full throttle, the first closing of the throttle would cause the engine to stop. This is due to the petrol being heated in the carburettor to a temperature above 50 degrees, which results in fuel starvation due to the petrol boiling and vaporising.

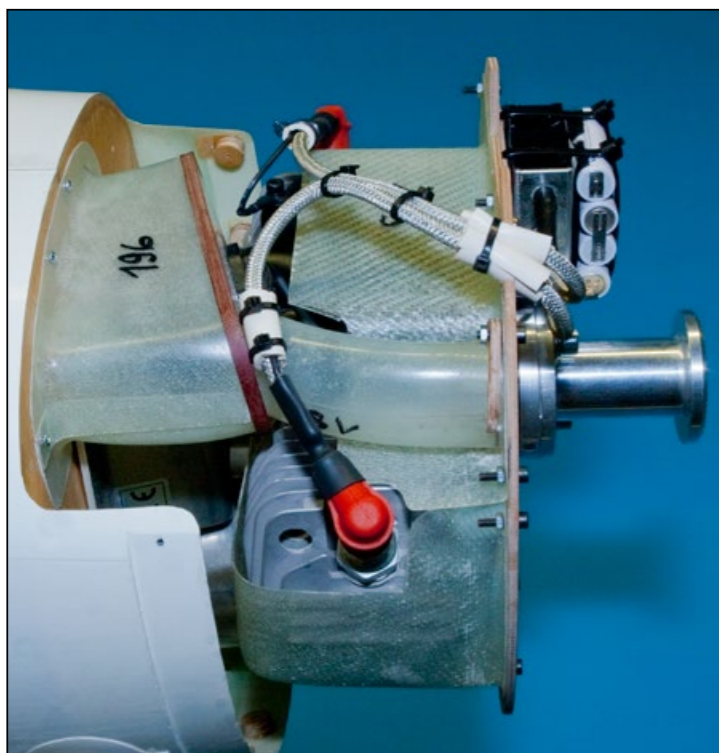

### Why the ZG80?

Firstly, the ZG 80 is a very compact engine and it fits very well into the slim Albatros fuselage. The power from the ZG 80 is more than enough for every type of aerobatic maneuvers. No matter whether in low level turns or enormous loops, or if you so wish, the wildest of 3d stunts are possible. The best is one can take off at a quarter throttle and fly, the resulting engine sound is so very realistic. The full-size Mercedes six cylinder is only just reaching 1,500rpm at take off power.

The ZG 80 is fairly insensitive to heat and well known for its robust reliability. In our prototype Albatros it has had hundreds of flying hours on so many flying meetings, in some cases under the most adverse weather conditions, all without any trace of unreliability. We have flown in temperatures of 35 degrees Celsius in the shade, without the slightest sign of overheating, clearly proving the effectiveness of the cooling.

*The 08/15 "Spandau" machine guns body parts, are made from hand layup epoxy glass laminate in our workshop, in moulds formed from CNC milled patterns. The gun barrel guard is CNC milled from phenolic paper tube. There are no wooden parts, so there is no irritating wood grain visible on steel components now or ever.*



### Imitation Engine and 08/15 MG's

The model Mercedes D111a engine is a real attraction, not being a heap of vacuum formed plastic sheet parts that must be cut out and trimmed, then glued together, resulting in most cases in a rather flimsy structure. Instead the engine is made from hand layup epoxy glass laminate, the same as the machine guns. All the engine parts have fine detail, e.g. the rocker shaft housing, inlet and exhaust valves with springs, water and oil pump and exhaust manifold. This gives such a realistic appearance that it is difficult to distinguish between the model and full-size. The two "Spandaus" with their filigrane gun barrel heat shields, CNC milled from tubing, so they remain fully circular, really add to the overall scale appearance, nestling either side of the engine cylinders. The small cocking levers for the MG's are cast from epoxy resin.

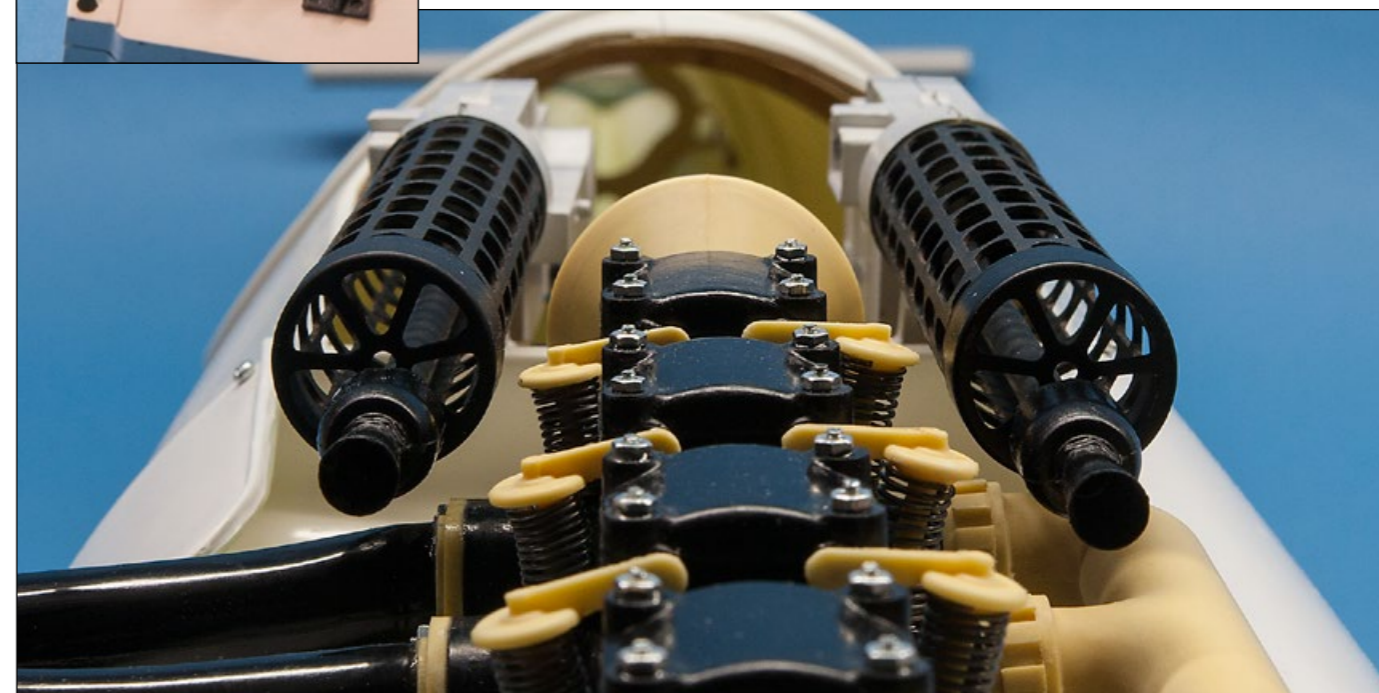
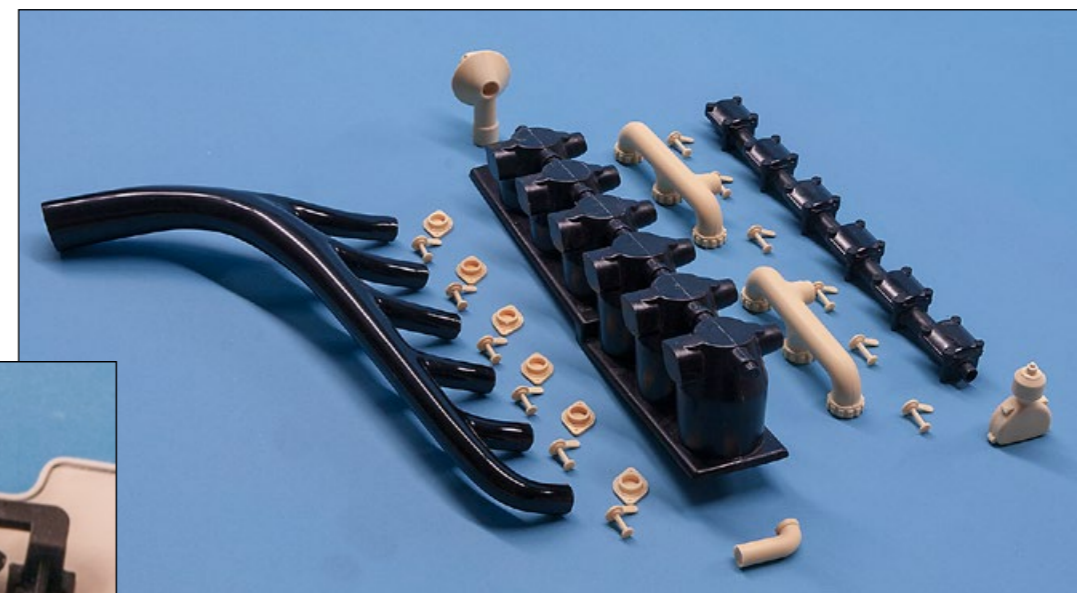



### Wing Incidence jig

Supplied in the kit is a precise wing rigging incidence jig. This to position accurately the wing centre section. The fuselage is mounted in this jig, using the lower wing moulded-in fixing holes and the lower wing Delrin® dowels. The upper wing Delrin® fixing dowels can be screwed either up or downwards until they fit exactly into the holes. This also enables the precision milled interplane struts to fit exactly. Just one more example of the many small, unusual ideas that are in our Albatros kit, as we claim "practical scale".

### Wing centre section struts and undercarriage legs formed from light stainless steel tubing

The centre section struts and undercarriage units, formed from stainless steel oval formed tubing, are completed with silver soldered fixing parts, ready to bolt to the fuselage. This construction is very light in weight as well as being very robust, looks superb and has the added advantage, that when the paint is chipped or scratched it shows the metal very realistically.



### GRP wheels

The spoked wheels fitted to the full-size Albatros were fitted with aluminium covers. Our kit wheels are laminated with Epoxy and Glassfiber, are far stronger than plastic wheels, and a lot lighter than spoked steel wheels.

### GRP axle fairing

This fairing opens by single sided springing of the axle, is identical to the full-size machine, having exactly the same form of springing with rubber shock cords.



### Stainless steel tubing ailerons

The ailerons are ready made, being silver soldered together in jigs, with the original washout. The hinge bodies are milled from wear resistant Tufnol, and the hinge flaps are formed from thin stainless steel. The ailerons are screwed to the wings, which is perfectly scale. The spindle moulded aileron leading edge is already cut to length to fit between the hinges.

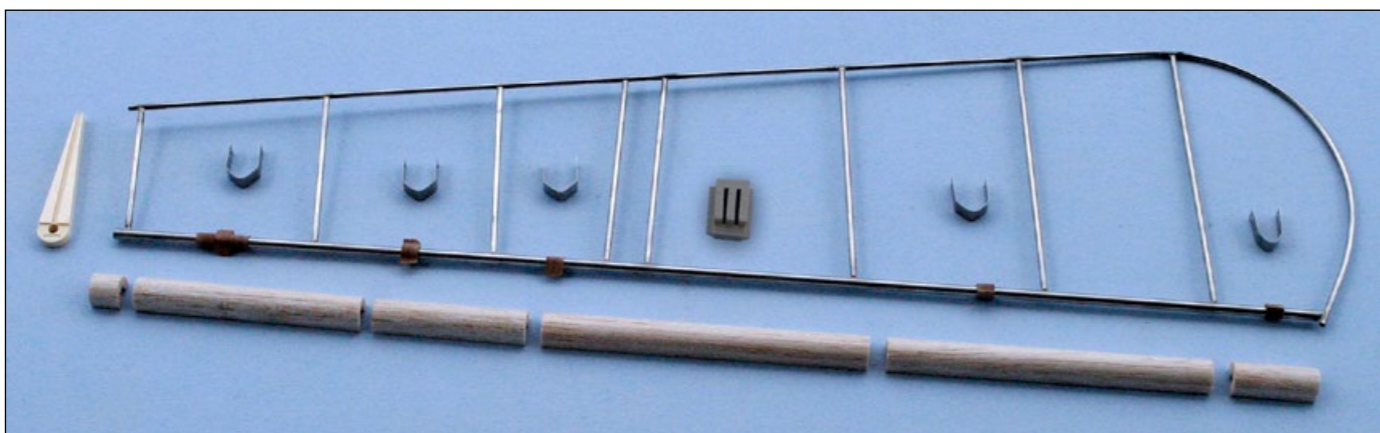

### The complete Albatros DVa kit contains:

- GRP fuselage with moulded in formers and stringers
- Imitation engine hand layup GRP and casting resin
- 08/15 Machine Guns GRP and casting resin, CNC milled parts
- GRP engine cowling
- Exact scale wheels, hand layup GRP
- Axle fairing, hand layup GRP with moulded in ribs
- Tailplane GRP vacuum formed sandwich construction
- Undercarriage legs and wing centre section struts from silver soldered air-foil section stainless steel tubing.
- CNC milled ribs and other parts, some even 3D milled
- Engine cooling cowling pieces made from GRP
- Cockpit coaming is real leather
- Three different shaped windscreens with preformed aluminium base frame
- GRP scale spinner
- Leading edges and integrated wing tips formed with GRP
- Ailerons ready made from thin wall stainless tubing
- Intricate Teeves water cooler kit
- Tailskid shaped in solid ash with silver soldered bearing
- All Nylon hinges and control horns
- Rigging tags, rigging wire and turnbuckles
- Fuel tank
- Jig to adjust the CS incidence
- Building manual with 300 pictures, parts list and identification plans
- CAD constructed plans for wings, elevators and rudder

### Albatros DVa complete kit ..... #8000 € 3880,—

To complete the model, the covering material, adhesives, the engine and radio gear is required.

